



*From pumps to process*

17 rue Ernest Laval - BP 35 - 92173 Vanves Cedex France  
Tel (33) 01 41 08 15 15 - Telex 634 129 F - Fax (33) 01 41 08 15 00  
Internet: pcm pompes.com Email: pcm@pcmpompes.com

# PCM Moineau

## Progressive Cavity Pumps I and ID Range

### Fields of application

Universal pumps are used in all branches of Industry :  
Building,  
Ceramics,  
Chemical,

Edible oil industry,  
Mining,  
Oil,  
Paper industry,  
Petrochemical,

Sewage treatment,  
Soap factories,  
Starch factories,  
Sugar refineries.



### Benefits

Non-pulsating flow,  
Flow directly proportional to speed,  
High self-priming capability,  
High efficiency,

Operates without valves,  
Reversible flow,  
Simple and heavy duty construction,  
Easy maintenance.

### I Serie

The I PCM MOINEAU pumps are used in all branches of industry where the products are viscous, abrasive,

heterogeneous, delicate and easily emulsified.

### ID Serie

The ID PCM MOINEAU pumps have been designed to be used when a uniform and accurate capacity is required or to

increase resistance to abrasion when abrasive products are handled.

### Performances

#### Capacity

Up to 500 m<sup>3</sup>/h.

#### Discharge pressure

Up to 45 bar in standard version and up to 200 bar on request.

#### Temperature

From 0 °C to + 110 °C  
higher temperature on request.



AF AQ N°1994/2612

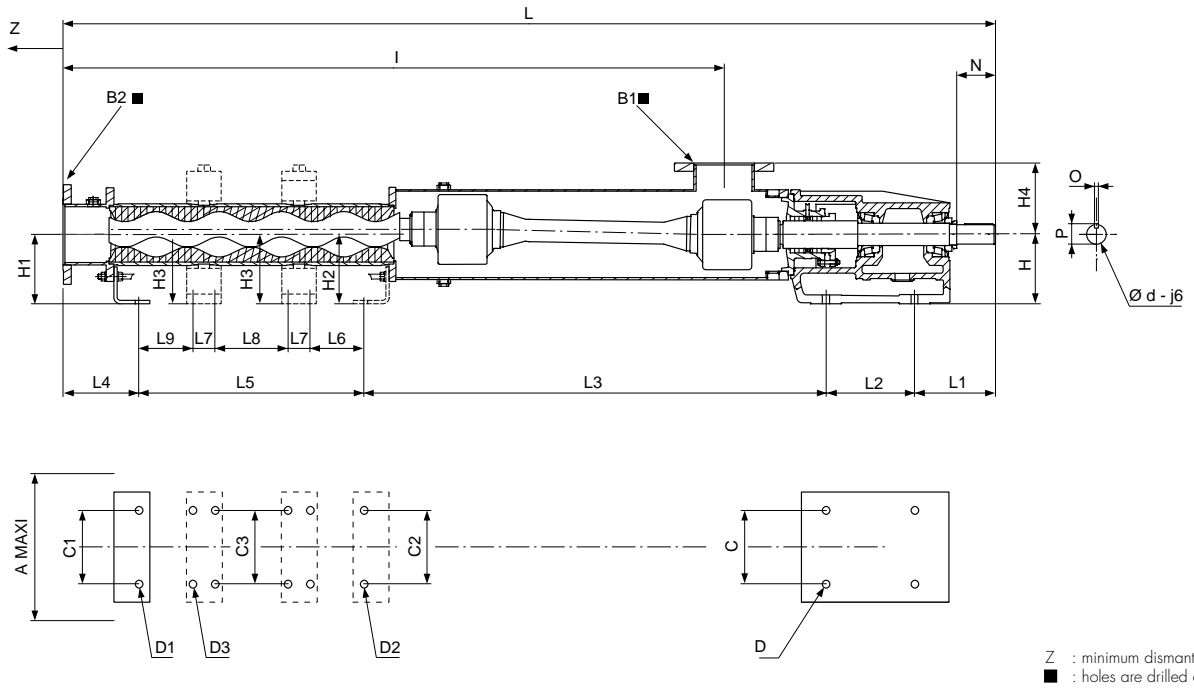

## Design features

### Body

The pump body is of A48 N°40 cast-iron or AISI 316L stainless steel construction. Special material available on request. Inspection port, double casing for heating or cooling are also available.

### Rotor

Depending on the product to be pumped, the rotor can be made of hardened steel, AISI 316L stainless steel, with or without chrome plating. Other materials are available.

### Stator

Stators are moulded to metal casings and can be made of nitrile, ethylene propylene, hypalon, viton, neoprene or natural rubber of various shore hardness. Cast iron and tufnol stators are also available.

### Rotating parts

According to rotor material and pumped product, rotating parts can be made of metallized steel, AISI 316 stainless steel, AISI 420 stainless steel, with or without chrome plating. Other materials are available.

### Bearings

The bearing housing is made of cast iron. The shaft is supported by two high capacity bearings, greased for life.

### Shaft seals

A comprehensive range of packed gland, single or double mechanical seal is available to suit all duty conditions.

### Drives

Electric motor, diesel/petrol engine, hydraulic motor, geared motor, variable speed geared motor, frequency inverter, d.c motor are available.

### Options

Circulating by-pass, dry running protection device, relief valve, capacity and pressure control device and many other accessories are available.

I Serie	Mounting									Dimensions												
	A maxi	C	F/I C1	C2	C3	D	D1	D2	D3	H	H3	H4	I	L	L1	L2	L6	L7	L8	L9	Z	H1
0.4 I 10	116	80	48/0				12			90		65	297	555	177						70	80
1 I 10	116	80	48/0			16	12			90		65	350	608	177						145	80
1.6 I 45	170	140	60			16	15			130		90	1065	1603	129	224					470	77
2.6 I 10	116	80	60/0			18	16			90		80	513	782	177						160	90
4 I 52	250	220	130	250		20	14	18		180		120	1614	222	168	295					640	140
6 I 5	116	80	60/0			16	16			90		80	432	700	177						120	90
6 I 10	140	95	70/0	0		16	16	16		112		100	F814 I848	F1126 I1164	220						210	112
6 I 20	140	95	70/0	0		16	16	16		112		100	1065	1381	220						460	112
13 I 5	140	95	70/0	0		16	16	16		112		100	753	1067	220						210	112
13 I 10	140	95	70/0	0		16	16	16		112		100	962	1276	220						420	112
13 I 20	180	140	140	140		16	16	18		130		130	1315	1883	129	224					700	125
20 I 4	140	95	70	70		14	16	16		112		103	985	1330	220						405	112
20 I 16	180	140	140	140		18	16	16		130		130	1584	2172	129	224					980	125
20 I 20	250	220	200	200		18	24	24		180		160	1775	2425	168	295					1050	140
20 I 40	350	220	200	200	310	20	24	24	20	180	140	160	2790	3440	168	295	939			936	1850	140
25 I 5	180	140	140			20	16			125		130	764	1303	115	224					185	125
25 I 10	180	140	140			18	16			130		130	1058	1616	129	224					470	125
30 I 4	170	140	140			18	18			130		130	980	1548	130	224					420	130
35 I 20	250	220	200	200		18	24	24		180		180	2093	2785	168	295					1160	140
35 I 40	250	220	200	200	200	20	24	24	24	180	140	200	3568	4286	168	295	1077		150	1077	2320	140
40 I 10	180	140	140	140		20	16	16		130		130	1360	1948	129	224					700	130
45 I 5	180	140	140			18	16			130		130	948	1536	129	224					305	130
50 I 15	280	220	200	230		18	22	22		180		200	2562	3280	168	295		80			1400	160
50 I 30	660	250	210	210	600	20	34	24	26	250	250	230	4022	4971	282	320	1472		1461		2720	250
60 I 10	250	220	200	200		26	22	22		180		180	1874	2560	168	295					890	160
62 I 5	185	140	120	120		18	18	18		130		130	1400	1970	129	224					390	130
90 I 5	185	140	120	120		18	18	18		130		130	1620	2190	129	224					610	130
100 I 10	280	220	230	230		18	22	22		180		200	2382	3100	168	295		80			1130	180
100 I 20	660	250	240	280	600	20	34	34	26	250	250	260	3890	4828	282	320	1280		1280		2330	250
120 I 5	280	220	230	230		26	22	22		180		190	1710	2408	168	295					600	180
150 I 10	280	220	230	230		20	22	22		180		200	2902	3620	168	295		80			1650	180
150 I 20	660	250	240	280	600	20	34	34	26	250	250	260	4930	5868	282	320	1800		1800		3380	250
180 I 5	280	220	230	230		26	22	22		180		190	2333	3030	168	295					1200	180
240 I 5	320	220	240	240		20	26	26		180		200	2435	3193	168	295		80			1200	250
240 I 10	660	250	320	320	600	20	34	34	26	250	250	250	3530	4502	282	320	1180	80	1165		2300	250
500 I 5	440	250	360	360		26	40	40		250		280	3092	4108	282	320					900	300

ID Serie	Mounting									Dimensions												
	A maxi	C	F/I C1	C2	C3	D	D1	D2	D3	H	H3	H4	I	L	L1	L2	L6	L7	L8	L9	Z	H1
0.03 ID 10	98	80	72			16	12			90		65	297	555	177						175	80
0.4 ID 10	116	80	48/0			16	12			90		65	400	657	177						175	80
1 ID 10	116	80	48/0			16	12			90		65	501	758	177						300	80
2.6 ID 10	116	80	60/0			16	16			90		80	723	992	177						370	90
6 ID 5	116	80	60/0			16	16			90		80	557	825	177						250	90
13 ID 10	140	95	70/0	0		16	16	16		112		100	1327	1641	220						740	112
35 ID 20	250	220	200	200	200	20	24	24	24	180	250	180	3319	4011	168	295	1072	163	1072		2390	140
40 ID 5	180	140	140	140		18	16	16		130		130	1360	1948	129	224					700	130
40 ID 10	180	140	140	140		18	16	16		130		130	1836	2424	129	224					1175	130
50 ID 15	660	220	230	230	600	20	22	22	26	180	250	200	4000	4720	168	295	1326	80	1318		2800	180
62 ID 5	185	140	120	120		18	18	18		130		130	1760	2330	129	224					750	130
100 ID 10	660	220	230	230	600	20	22	22	26	180	250	200	3630	4347	168	295	1166		1126		2380	180
150 ID 10	660	220	230	230	600	20	22	22	24	180	250	200	4670	5387	168	295	1646	80	1646		3400	180
240 ID 5	660	220	230	230	600	20	30	30	26	180	250	200	3582	4341	168	295	1168	80	1168		2350	250

All dimensions given are for guidance only. PCM POMPES reserves the right to change specifications without notice.

# Progressive Cavity Pumps I and ID Range

Cast-iron					Stainless-steel					Connection				Shaft end				Weight
H2	L3	L4	L5		H1	H2	L3	L4	L5	B1 PN	B1 DN	B2 PN	B2 DN	d	N	O	P	kg
	350	28			80		327	28		16	20	16	20	20	50	6	22.5	18
	403	28			80		38	28		16	20	16	20	20	50	6	22.5	19
	1220	30			77		1220	30		Ø 34	BSP	Ø 34	BSP	38	60	10	41	65
	557	47			90		530	74		16	40	16	40	20	50	6	22.5	25
140	911	115	733		140	140	911	115	733	Ø 51	PDG	Ø 51	PDG	55	110	16	59	140
	475	47			90		450	74		10	40	10	40	20	50	6	22.5	22
112	573	45	288		112	112	569	107	268	16	50	16	50	28	50	8	31	31
112	573	45	543		112	112	569	71	543	25	50	25	50	28	50	8	31	38
112	573	45	229		112	112	569	74	204	16	50	16	50	28	50	8	31	30
112	573	45	438		112	112	569	45	413	16	50	16	50	28	50	8	31	35
130	685	50	795		125	130	685	50	795	16	100	40	65	38	60	10	41	95
112	602	46	462		125	130	685	50	795	16	80	16	65	28	50	8	31	47
130	736	50	1033		125	130	690	50	1082	16	125	16	100	38	60	10	41	140
140	920	180	862		140	140	920	180	862	16	125	40	100	55	110	16	59	225
140	920	180	1877		140	140	920	180	1877	16	125	40	100	55	110	16	59	312
	914	50			125		899	50		16	100	16	100	38	60	10	41	77
	1213	50			125		1198	50		16	100	16	100	38	60	10	41	95
	1145	50								16	100	16	100	38	60	10	41	92
140	1064	177	1081		140	140	1064	177	1081	16	150	40	125	55	110	16	59	285
140	1342	177	2304		140	140	1342	177	2304	10	200	40	125	55	110	16	59	380
125	736	74	785		125	125	690	74	831	16	125	16	125	38	60	10	41	135
	1110	74	0		125		1110	74		16	125	16	125	38	60	10	41	115
180	1336	213	1268		160	180	1336	213	1268	10	200	16	150	55	110	16	59	387
250	1261	95	3013		250	250	1261	95	3013	40	200	40	150	70	140	20	74.5	640
160	1052	215	830		160	160	1052	215	830	16	150	16	150	55	110	16	59	315
130	1061	170	386		130	130	1061	170	386	16	125	16	125	38	60	10	41	195
130	1061	170	606		130	130	1061	170	606	16	125	16	125	38	60	10	41	230
180	1318	234	1085		180	180	1318	234	1085	10	200	10	200	55	110	16	59	405
250	1491	95	2640		250	250	1491	95	2640	25	200	25	200	70	140	20	74.5	1050
180	1249	234	462		180	180	1249	234	462	10	200	10	200	55	110	16	59	305
180	1318	234	1605		180	180	1318	234	1605	10	200	10	200	55	110	16	59	440
250	1491	95	3680		250	250	1491	95	3680	25	200	25	200	70	140	20	74.5	1450
180	1249	234	1085		180	180	1249	234	1085	10	200	10	200	55	110	16	59	385
250	1360	102	1268		250	250	1360	102	1268	10	250	10	250	55	110	16	59	440
250	1375	100	2425		250	250	1375	100	2425	10	250	16	250	70	140	20	74.5	900
300	2016	180	1310		300	300	2016	180	1310	10	300	10	300	70	140	20	74.5	1250

Cast-iron					Stainless-steel					Connection				Shaft end				Weight
H2	L3	L4	L5		H1	H2	L3	L4	L5	B1 PN	B1 DN	B2 PN	B2 DN	d	N	O	P	kg
	346	28			80		313	374		16	20	16	20	20	50	6	22.5	19
	450	28			80		430	50		16	20	16	20	20	50	6	22.5	19
	553	28			80		530	50		16	20	16	20	20	50	6	22.5	20
	762	47			90		735	74		16	40	16	40	20	50	6	22.5	27
112	600	47			90		575	74		16	40	16	40	20	50	6	22.5	25
	573	45	803		112	112	569	45	778	16	50	16	50	28	50	8	31	56
130	1064	177	2307		140	140	1064	177	2307	16	150	40	125	55	110	16	59	365
130	736	74	785		125	125	690	74	831	16	125	16	125	38	60	10	41	135
180	736	74	1260		125	125	690	74	1305	16	125	16	125	38	60	10	41	165
130	1319	214	2724		180	180	1319	214	2724	10	200	16	150	55	110	16	59	525
180	1061	170	746		130	130	1061	170	746	16	125	16	125	38	60	10	41	245
180	1318	234	2332		180	180	1318	234	2332	10	200	10	200	55	110	16	59	580
250	1318	234	3372		180	180	1318	234	3372	10	200	10	200	55	110	16	59	685
	1360	102	2416		250	250	1360	102	2416	10	250	10	250	55	110	16	59	695

# Progressive Cavity Pumps I and ID Range

## Curves

The indicated speeds and pressures are related to pumps handling water at 20 °C or fluid of the same viscosity. Operating speed is affected by abrasion and viscosity.

The operating conditions, accuracy, service, NPSH available must be examined to determine the most suitable pump for your application.

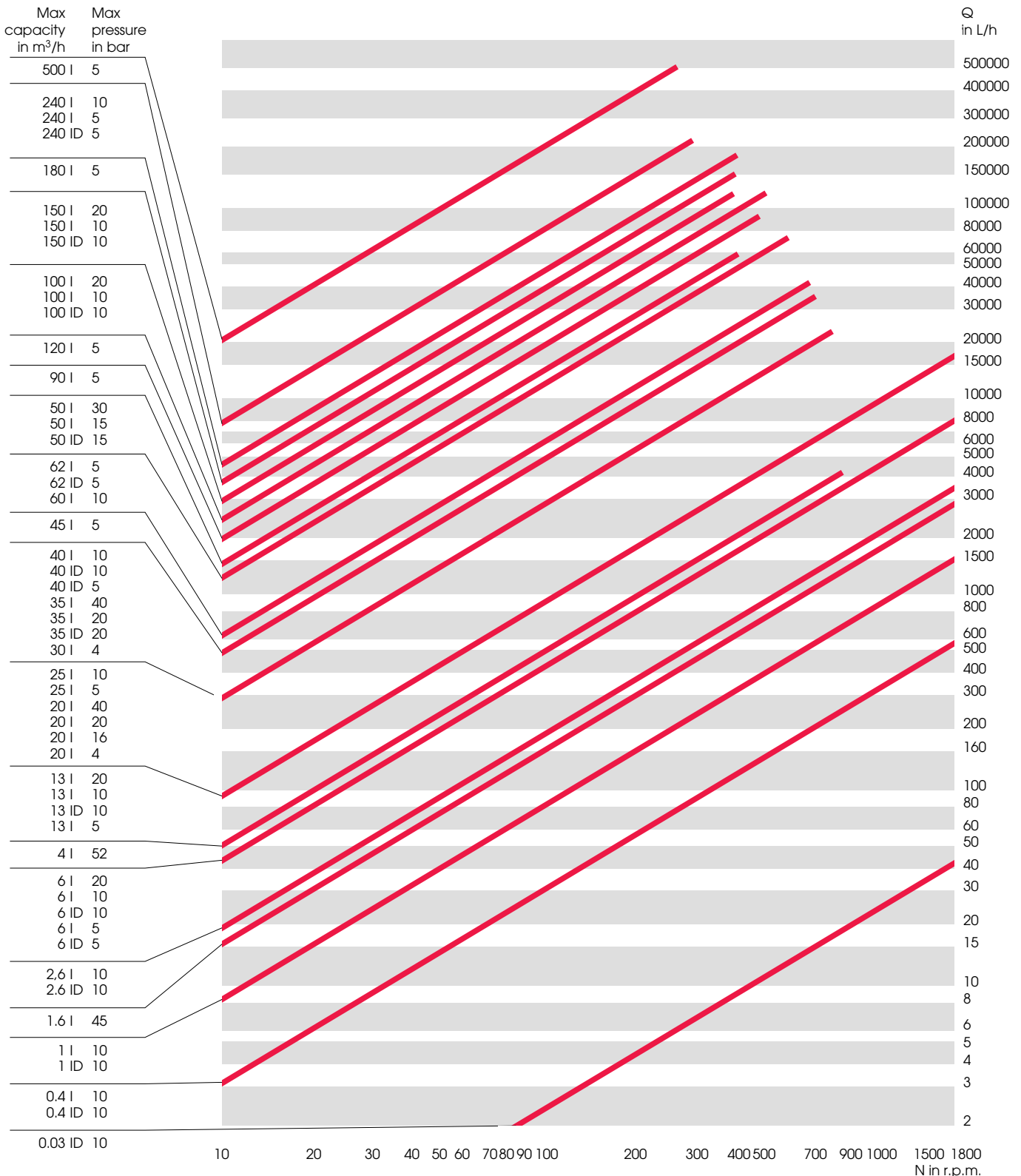



*From pumps to process*

17 rue Ernest Laval - BP 35 - 92173 Vanves Cedex France  
Tel (33) 01 41 08 15 15 - Telex 634 129 F - Fax (33) 01 41 08 15 00  
Internet: pcmompes.com Email: pcm@pcmompes.com

# Progressive Cavity Pumps I and ID Range

## Arrangements

Pump driven by geared motor with coupling on base frame.

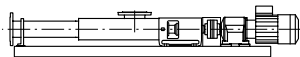

Pump driven by variable speed geared motor with coupling on base frame.

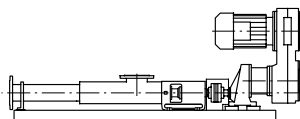

Pump driven by electric-motor and coupling on base frame.



Pump driven by electric-motor and V-belt, on base frame.

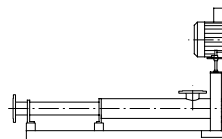

Pump driven by electric-motor and coupling on trolley.

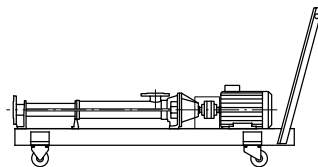

Pump driven by engine, with coupling and clutch, on base frame.

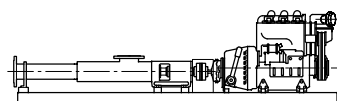

## Shaft sealing options

### Packed gland

A simple, low-cost and easy-to-maintain sealing arrangement.

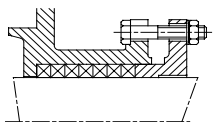

### Packed gland with flushing and lantern ring

A low-cost packing arrangement for sealing abrasive products.

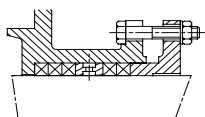

### Single mechanical seal

Provides long life and leak-free-sealing. Balanced, single acting with capsulated spring. To suit the required service, a variety of seal material are available : ceramic/carbon, silicon carbide/silicon carbide, etc...

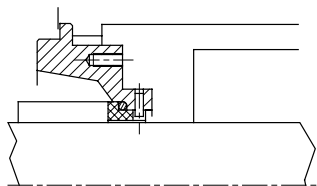

### Single mechanical seal with quench

Identical to single mechanical seal. Quench fluid cools seal, washes leakage away, prevents crystallization of leakage and dry running.

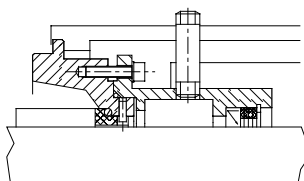

### Mechanical seal in tandem arrangement

Using clean liquid, pressurized or not, between the two mechanical seals. Suitable for abrasive liquids, toxic and hazardous fluids as well as high vapor pressure fluids.

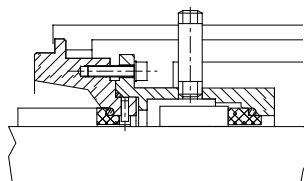

### Special seal arrangement

Other seal arrangements are available on request for special application :

- back to back arrangement,
- outside arrangement.

## Progressive Cavity Pumps MR/MV-I and MR/MV-ID Range

### Fields of application

This range of pumps are used in all branches of Industry :

- Building,
- Ceramics,
- Chemical,

- Edible oil industry,
- Mining,
- Oil,
- Paper industry,
- Petrochemical,

- Sewage treatment,
- Soap factories,
- Starch factories,
- Sugar refineries.



### Benefits

- Non-pulsating flow,
- Flow directly proportional to speed,
- High self-priming capability,
- High efficiency,

- Operates without valves,
- Reversible flow,
- Simple and heavy duty construction,
- Easy maintenance.

### MR/MV-I Serie

The monobloc range is designed with geared motor (MR) or variable speed geared motor (MV) directly flanged into the pump.

Used in all branches of industry where the products are viscous, abrasive heterogeneous, delicate and easily emulsified.

### MR/MV-ID Serie

Specially designed to be used when a uniform and accurate capacity is required or to increase resistance to abrasion

when abrasive products are handled.

### Performances

**Capacity**  
Up to 180 m<sup>3</sup>/h.

**Discharge pressure**  
Up to 45 bar in standard version and up to 200 bar on request.

**Temperature**  
From 0 °C to + 110 °C  
higher temperature on request.

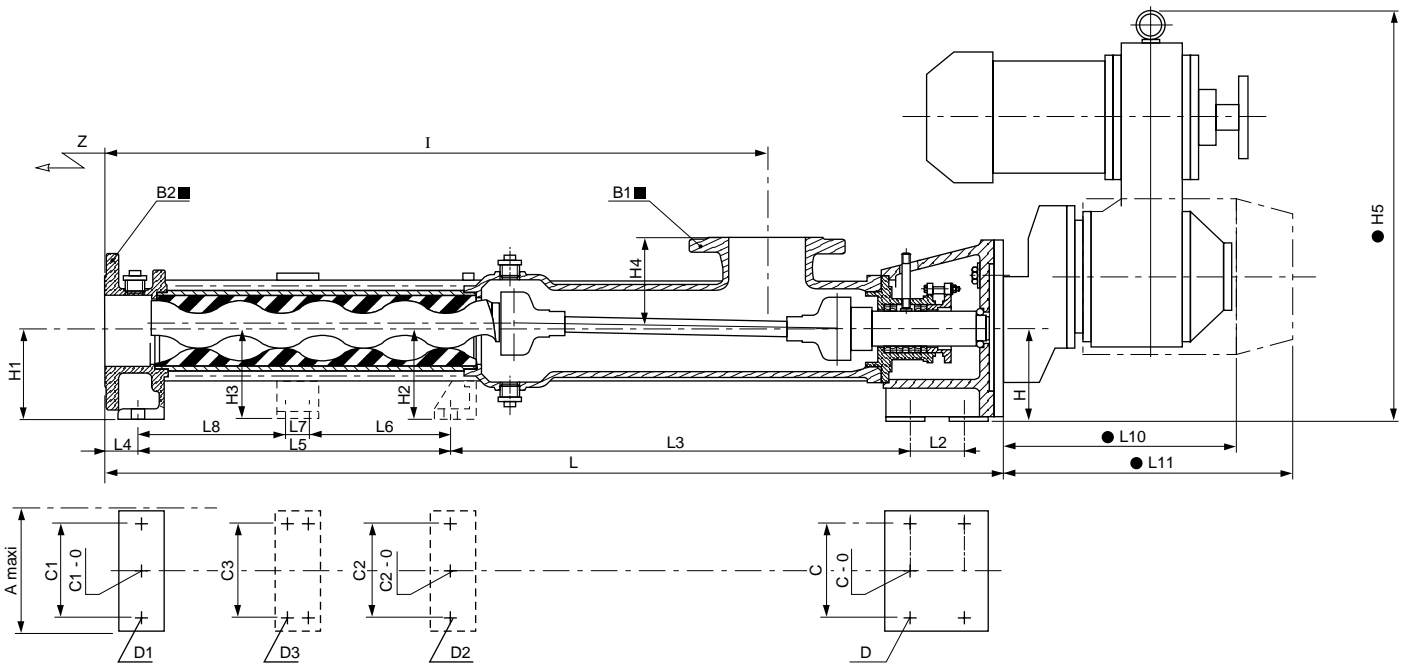

Z : minimum dismantling space  
 ■ : holes are drilled off centerlines  
 ● : for guidance only

## Design features

### Body

The pump body is of A48 N°40 cast-iron or AISI 316L stainless steel construction. Special material available on request. Inspection port, double casing for heating or cooling are also available.

### Rotor

Depending on the product to be pumped, the rotor can be made of hardened steel, AISI 316L stainless steel, with or without chrome plating. Other materials are available.

### Stator

Stators are moulded to metal casings and can be made of nitrile, ethylene propylene, hypalon, viton, neoprene or natural rubber of various shore hardness.

### Rotating parts

According to rotor material and pumped product, rotating parts can be made of metallized steel, AISI 316 stainless steel, AISI 420 stainless steel, with or without chrome plating. Other materials are available.

### Shaft seals

A comprehensive range of packed gland, single or double mechanical seal is available to suit all duty conditions.

### Drives

Pumps are driven by geared motor or variable speed geared motor, directly flanged into the pump. Frequency inverter or d.c motor are also available. Hydraulic motor can be supplied on request.

### Options

Circulating by-pass, dry running protection device, relief valve, capacity and pressure control device and many other accessories are available.



MR/MV-I Serie	Mounting									Dimensi												
	Type	A maxi	C	CI/SS C1	C2	C3	D	D1	D2	D3	H	H3	H4	H5	I	L	L2	L6	L7	L8	L10	L11
MR/MV 0.4 I 10	116	80	48/0			16	12			90		65	425	297	414						570	465
MR/MV 1 I 10	116	80	48/0			16	12			90		65	425	350	467						570	465
MR/MV 1.6 I 45	170	140	60			18	16			130		90	830	1065	1370	80					610	650
MR/MV 2.6 I 10	116	80	60/0			16	16			90		80	425	513	635						570	465
MR/MV 4 I 52																						
MR/MV 6 I 5	116	80	60/0			16	16			90		80	425	432	555						570	465
MR/MV 6 I 10	140	95	70/0	0		16	16	16		112		100	595	F 814 1848	F 956 1994						575	560
MR/MV 6 I 20	140	95	70	-		14	14	-	-	112		103	595	1066	1379	-		-	-		610	650
MR/MV 13 I 5	140	95	70/0	0		16	16	16		112		100	595	753	897						575	560
MR/MV 13 I 10	140	95	70/0	0		16	16	16		112		100	595	962	1106						575	560
MR/MV 13 I 20	180	140	140	140		18	16	18		130		130	830	1315	1640	80					610	650
MR/MV 20 I 4	140	95	70	70		14	16	16		112		103	595	985	1160						575	560
MR/MV 20 I 16	180	140	140	140		18	16	16		130		130	830	1584	1930	80					610	650
MR/MV 20 I 20	250	220	200	200		20	20	20		180		160	830	1775	2120	100					835	832
MR/MV 25 I 5	180	140	140			18	16			130		130	830	764	1085	80					610	650
MR/MV 25 I 10	180	140	140			18	16			130		130	830	1058	1379	80					610	650
MR/MV 30 I 4	170	140	140			18	18			130		130	830	980	1296						610	650
MR/MV 35 I 20	250	220	200	200		20	20	20		180		180	830	2093	2480	100					835	832
MR/MV 40 I 10	180	140	140	140		18	16	16		130		130	830	1360	1701	80					610	650
MR/MV 45 I 5	180	140	140			18	16			130		130	830	948	1289	80					610	650
MR/MV 60 I 10	250	220	200	200		20	22	22		180		180	830	1874	2255	100					835	832
MR/MV 62 I 5	185	140	120	120		18	18	18		130		130	830	1400	1740	80					610	650
MR/MV 90 I 5	185	140	120	170		18	18	18		130		130	830	1620	1943	80					610	650
MR/MV 100 I 10	280	220	230	230		20	22	22		180		200	830	2382	2795	100					835	832
MR/MV 120 I 5	280	220	230	230		20	22	22		180		190	830	1710	2103	100					835	832
MR/MV 180 I 5	280	220	230	230		20	22	22		180		190	830	2333	2726	100					835	832

① Weight without drive

MR/MV-ID Serie	Mounting									Dimensi												
	Type	A maxi	C	CI/SS C1	C2	C3	D	D1	D2	D3	H	H3	H4	H5	I	L	L2	L6	L7	L8	L10	L11
MR/MV 0.03 ID 10	98	80	72			16	12			90		65	425	297	414						570	465
MR/MV 0.4 ID 10	116	80	48/0			16	12			90		65	425	400	512						570	465
MR/MV 1 ID 10	116	80	48/0			16	12			90		65	425	501	615						570	465
MR/MV 2.6 ID 10	116	80	60/0			16	16			90		80	425	723	845						570	465
MR/MV 6 ID 5	116	80	60/0			16	16			90		80	425	557	680						570	465
MR/MV 13 ID 10	140	95	70/0	0		16	16	16		112		100	595	1327	1471						575	560
MR/MV 40 ID 5	180	140	140			18	16			130		130	948	1360	1701	80					610	650
MR/MV 40 ID 10	180	140	140	140		18	16	16		130		130	830	1834	2175	80					610	650
MR/MV 62 ID 5	185	140	120	120		18	18	18		130		130	830	1760	2100	80					610	650
MR/MV 100 ID 10	660	220	230	230	600	20	22	22	26	180		200	830	3630	4042	100					835	832
MR/MV 150 ID 10	660	220	230	230	600	20	22	22	26	180	250	200	830	4670	5082	100	1646	80	1646	835	832	3

All dimensions given are for guidance only. PCM POMPES reserves the right to change specifications without notice.

# Progressive Cavity Pumps MR/MV-I and MR/MV-ID Range

Z	Dimensions										Connection				Weight
	Cast-iron					Stainless steel					B1		B2		kg
	H1	H2	L3	L4	L5	H1	H2	L3	L4	L5	PN	DN	PN	DN	
70	80		350	28		80		327	50		16	20	16	20	17
145	80		403	28		80		380	50		16	20	16	20	18
470	77		1220	30		77		1220	30		Ø 34	BSP	Ø 34	BSP	59
160	90		557	47		90		530	74		16	40	16	40	24
120	90		475	47		90		450	74		10	40	10	40	21
210	112	112	573	45	288	112	112	569	107	268	10	50	16	F 50 I 40	30
450	112	112	597	43	520	112	112	597	43	520	25	50	25	50	33
210	112	112	573	45	229	112	112	569	74	204	16	50	16	50	28
420	112	112	597	45	438	112	112	569	74	413	16	50	16	50	33
700	125	130	671	50	795	125	130	671	50	795	16	100	40	65	90
405	112	112	602	46	462						16	80	16	65	130
980	125	130	722	50	1033	125	125	676	47	1082	16	125	16	100	125
050	140	140	920	180	862	140	140	920	180	862	16	125	40	100	191
185	125		910	50		125		915	65		16	100	16	100	71
470	125		1200	50		125		1209	65		16	100	16	100	87
420	130		1145	50							16	100	16	100	180
160	140	Option 140	1064	177	1081	140	140	1064	177	1081	16	150	40	125	251
700	130	130	722	74	785	125	125	676	74	831	16	125	16	125	129
305	130		1096	74		130		1069	74		16	125	16	125	108
890	160	160	1052	215	830	160	160	1052	215	830	16	150	16	150	280
390	130	130	1047	170	386	130	130	1047	170	386	16	125	16	125	188
390	130	130	1047	170	606	130	130	1047	170	606	16	125	16	125	153
130	180	180	1318	234	1085	180	180	1318	234	1085	10	200	10	200	370
600	180	180	1249	234	462	180	180	1249	234	462	10	200	10	200	270
200	180	180	1249	234	1085	180	180	1249	234	1085	10	200	10	200	351

Z	Dimensions										Connection				Weight
	Cast-iron					Stainless steel					B1		B2		kg
	H1	H2	L3	L4	L5	H1	H2	L3	L4	L5	PN	DN	PN	DN	
70	80		346	28		80		313	61		16	20	16	20	18
175	80		450	28		80		430	50		16	20	16	20	18
300	80	90	553	28		80		530	50		16	20	16	20	19
370	90		767	47		90		740	74		16	40	16	40	26
250	90		600	47		90		575	74		16	40	16	40	24
740	112	112	573	45	803	112	112	569	74	778	16	50	16	50	55
700	130	130	722	74	785	125	125	676	74	831	16	125	16	125	127
175	130	130	722	74	1260	125	125	676	74	1305	16	125	16	125	157
750	130	130	1047	170	746	130	130	1047	170	746	16	125	16	125	219
580	180	180	1318	234	2332	180	180	1318	234	2332	10	200	10	200	525
400	180	180	1318	234	3372	180	180	1318	234	3372	10	200	10	200	630

# Progressive Cavity Pumps MR/MV-I and MR/MV-ID Range

## Curves

The indicated speeds and pressures are related to pumps handling water at 20 °C or fluid of the same viscosity. Operating speed is affected by abrasion and viscosity.

The operating conditions, accuracy, service, NPSH available must be examined to determine the most suitable pump for your application.

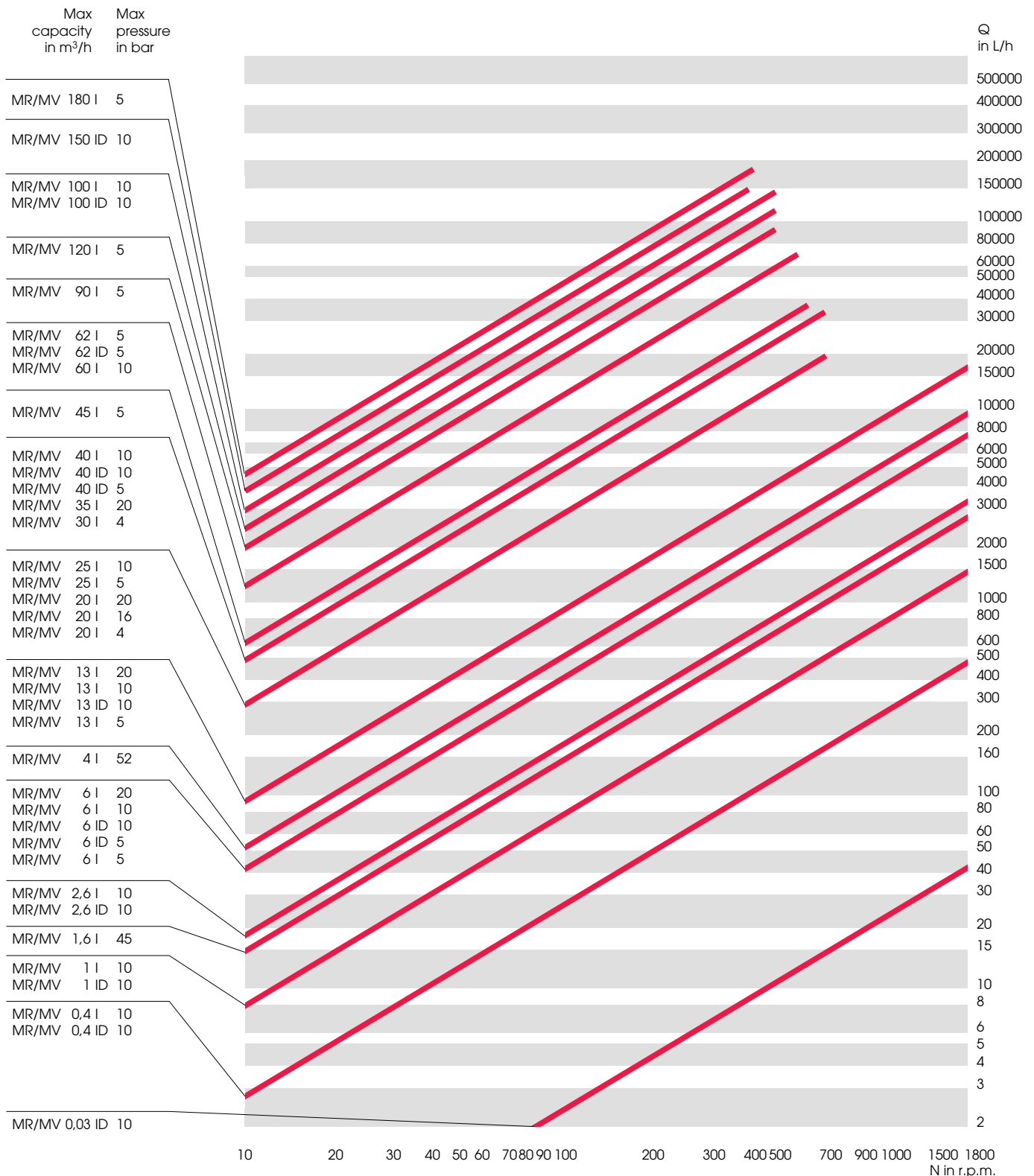

# Progressive Cavity Pumps MR/MV-I and MR/MV-ID Range

## Shaft sealing options

### Packed gland

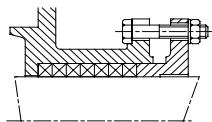

A simple, low-cost and easy to maintain sealing arrangement.

### Packed gland with flushing and lantern ring

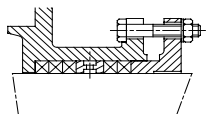

A low-cost packing arrangement for sealing abrasive products.

### Single mechanical seal

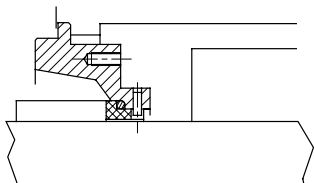

Provides long life and leak-free sealing. Balanced, single acting with capsulated spring. To suit the required service, a variety of seal material are available : ceramic/carbon, silicon carbide/silicon carbide, etc...

### Single mechanical seal with quench

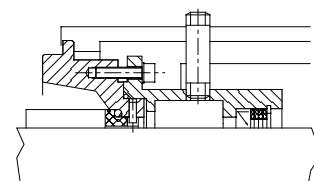

Identical to single mechanical seal. Quench fluid cools seal, washes leakage away, prevents crystallization of leakage and dry running.

### Mechanical seal in tandem arrangement

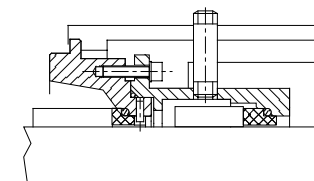

Using clean liquid, pressurized or not, between the two mechanical seals. Suitable for abrasive liquids, toxic and hazardous fluids as well as high vapor pressure fluids.

### Special seal arrangement

Other seal arrangements are available on request for special application :

- back to back arrangement,
- outside arrangement.